

DESCRIPTION

The dual monolithic silicon Zener diodes are designed for applications requiring transient overvoltage protection capability. They are intended for use in voltage and ESD sensitive equipment such as computers, printers, business machines, communication systems, medical equipment and other applications. Their dual junction common anode design protects two separate lines using only one package. These devices ideal for situations where board space is at a premium.

FEATURES

- ◇ SOT-23 package allows either two separate unidirectional configurations or a single bidirectional configuration.
- ◇ Working peak reverse voltage 3V to 22V
- ◇ Standard Zener breakdown voltage 5.6V to 27V
- ◇ Peak power 24 or Watts @ 1.0ms (unidirectional) per Figure 6 Waveform
- ◇ ESD Rating:
 - Class 3B (>16kV) per the Human Body Model
 - Class C (>400V) per Machine Model
- ◇ ESD Rating of IEC61000-4-2 level 4, ± 30 kV contact Discharge
- ◇ Low leakage < 5.0 μ A

MACHANICAL DATA

- ◇ SOT-23 package
- ◇ Flammability Rating: UL 94V-0
- ◇ Packaging: Tape and Reel
- ◇ High temperature soldering guaranteed: 260°C/10s
- ◇ Reel size: 7 inch

ORDERING INFORMATION

- ◇ Device: KMMBZxxALT1G
- ◇ Package: SOT-23
- ◇ Material: RoHS Compliant
- ◇ Packing: Tape & Reel
- ◇ Quantity per reel: 3,000pcs

APPLICATIONS

- ◇ Computers
- ◇ Printers
- ◇ Business Machines
- ◇ Communication systems
- ◇ Medical equipment

PIN CONFIGURATION

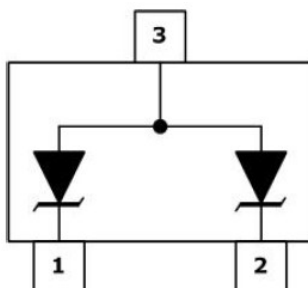

PACKAGE OUTLINE

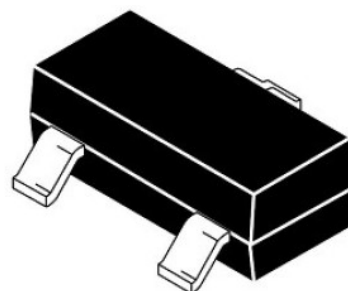

ABSOLUTE MAXIMUM RATING

Symbol	Parameter	Value	Units
P _{PK}	Peak Power Dissipation @1.0ms	24	W
	KMMBZ5V6ALT1G THRU KMMBZ9V1ALT1G KMMBZ12VALT1G THRU KMMBZ27VALT1G	40	
P _D	Total Power Dissipation	200	mW
T _{OPT}	Operating Temperature	-55/+150	°C
T _{STG}	Storage Temperature	-55/+150	°C

24 WATTS
ELECTRICAL CHARACTERISTICS (T_{amb}=25°C)
UNIDIRECTIONAL (Circuit tied to Pins 1 and 3 or Pins 2 to 3)

Part Number	Device Marking	V _{RWM}	I _R	V _{BR}			Z _{ZT}	Z _{ZK}		V _C		
		(V)	(μA)	(V)			(Ω)	(Ω)	(mA)	(V)	(A)	
			@ V _{RWM}	Min	Nom	Max	@ I _T	Max @ I _{ZT}	Max	@ I _{ZK}	Max	@ I _{PP}
KMMBZ5V6ALT1G	5A6	3.0	5.0	5.32	5.6	5.88	20	11	1600	0.25	8.0	3.0
KMMBZ6V2ALT1G	6A2	3.0	0.5	5.89	6.2	6.51	1.0	--	--	--	8.7	2.76
KMMBZ6V8ALT1G	6A8	4.5	0.5	6.46	6.8	7.14	1.0	--	--	--	9.6	2.5
KMMBZ9V1ALT1G	9A1	6.0	0.3	8.65	9.1	9.56	1.0	--	--	--	14	1.7

 V_F=0.9V Max @ I_F=10mA

40 WATTS
ELECTRICAL CHARACTERISTICS (T_{amb}=25°C)
UNIDIRECTIONAL (Circuit tied to Pins 1 and 3 or Pins 2 to 3)

Part Number	Device Marking	V _{RWM}	I _R	V _{BR}				V _C (note1)	
		(V)	(nA)	(V)			(mA)	(V)	(A)
			@ V _{RWM}	Min	Nom	Max	@ I _T	Max	@ I _{PP}
KMMBZ12VALT1G	12A	8.5	200	11.40	12	12.60	1	17	2.35
KMMBZ15VALT1G	15A	12.0	50	14.25	15	15.75	1	21	1.90
KMMBZ18VALT1G	18A	14.5	50	17.10	18	18.90	1	25	1.60
KMMBZ27VALT1G	27A	22.0	50	25.65	27	28.35	1	40	1.0

 V_F=0.9V Max @ I_F=10mA

Note 1: Surge Current waveform per Figure 5

ELECTRICAL CHARACTERISTICS CURVE

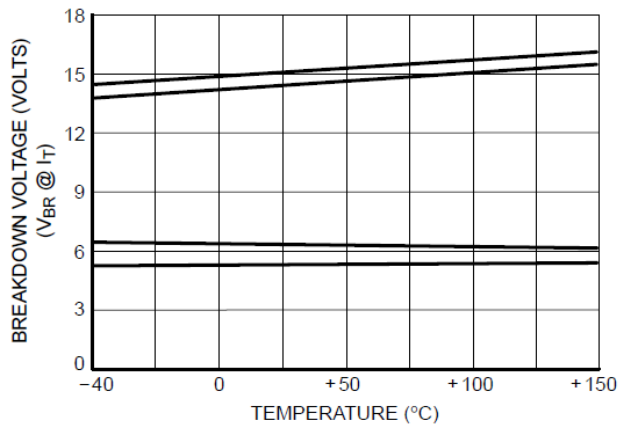

Figure 1. Typical Breakdown Voltage versus Temperature

(Upper curve for each voltage is bidirectional mode, lower curve is unidirectional mode)

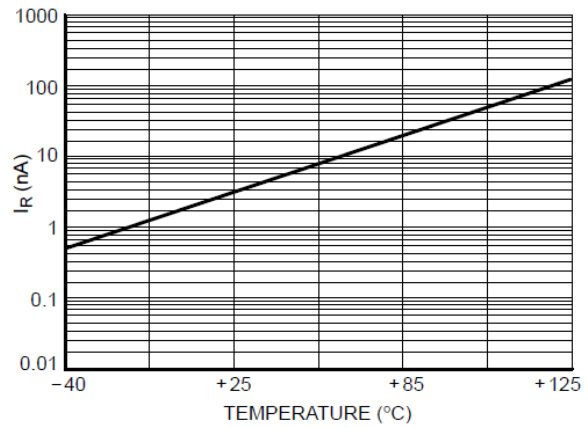

Figure 2. Typical Leakage Current versus Temperature

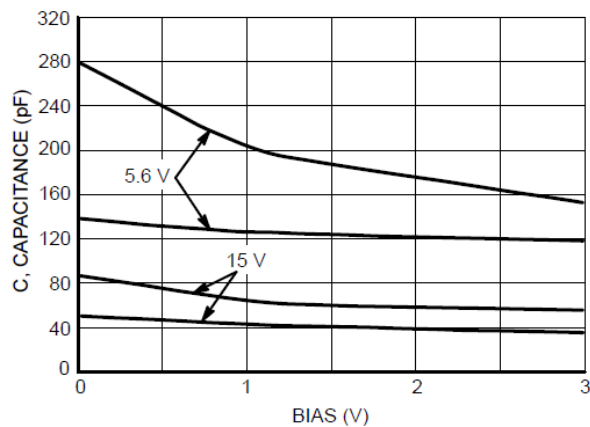

Figure 3. Typical Capacitance versus Bias Voltage

(Upper curve for each voltage is unidirectional mode, lower curve is bidirectional mode)

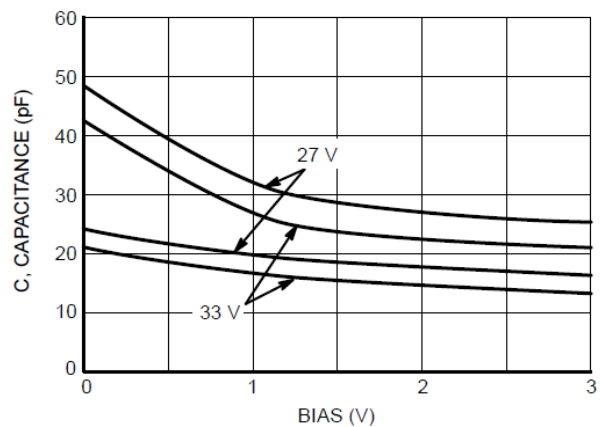

Figure 4. Typical Capacitance versus Bias Voltage

(Upper curve for each voltage is unidirectional mode, lower curve is bidirectional mode)

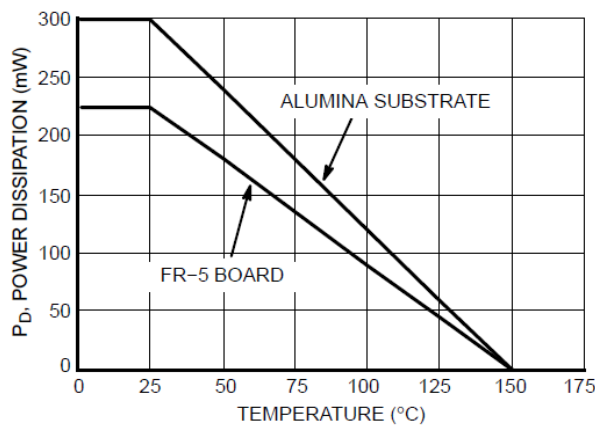

Figure 5. Steady State Power Derating Curve

ELECTRICAL CHARACTERISTICS CURVE

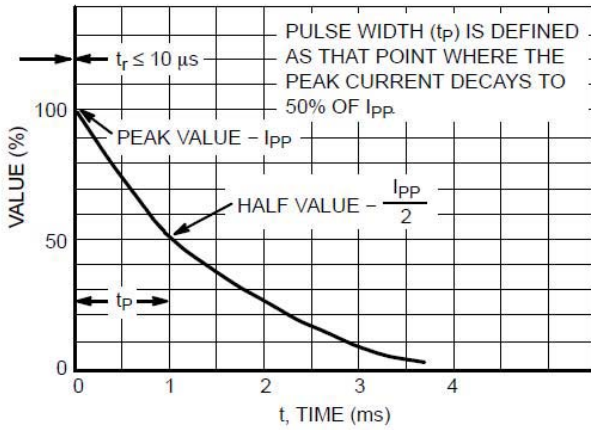

Figure 6. Pulse Waveform

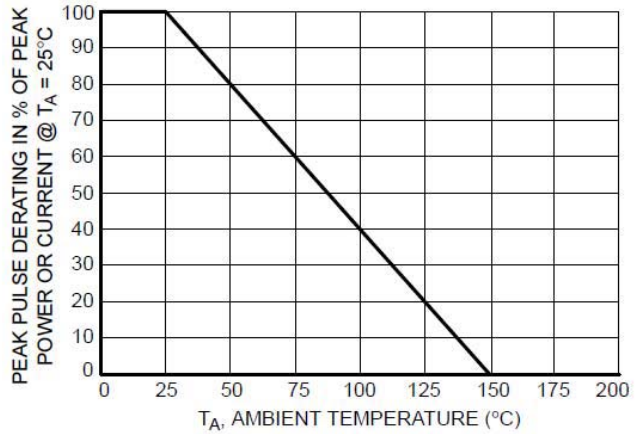

Figure 7. Pulse Derating Curve

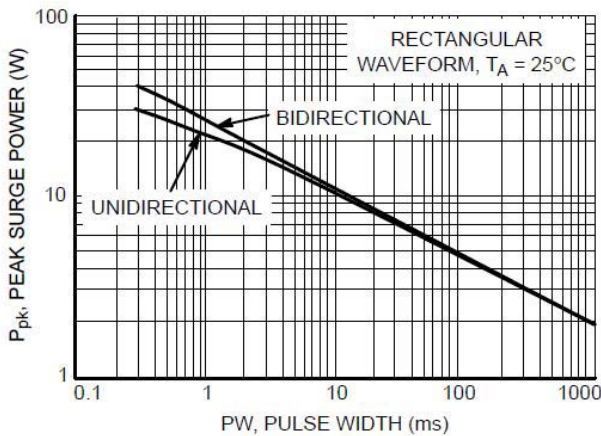

Figure 8. Maximum Non-repetitive Surge Power, P_{pk} versus PW

Power is defined as $V_{RSM} \times I_Z(pk)$ where V_{RSM} is the clamping voltage at $I_Z(pk)$.

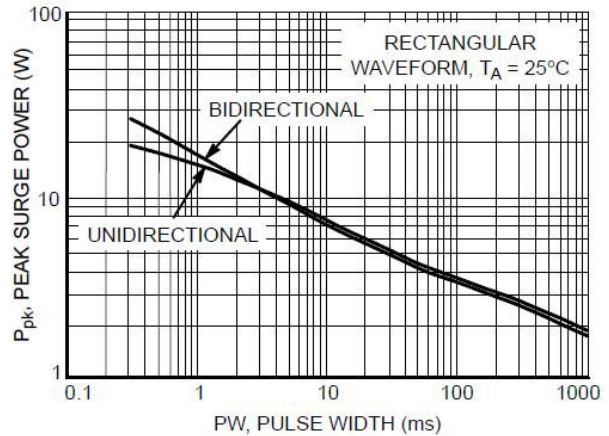
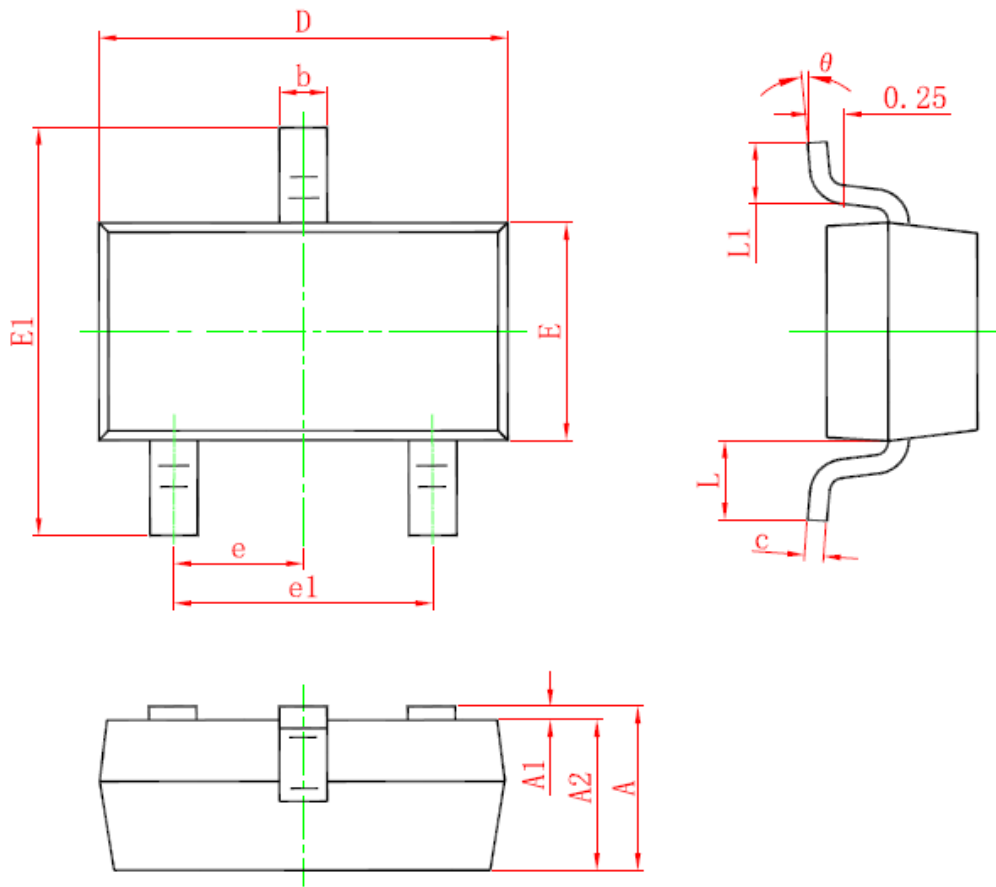

Figure 9. Maximum Non-repetitive Surge Power, $P_{pk(NOM)}$ versus PW

Power is defined as $V_Z(NOM) \times I_Z(pk)$ where $V_Z(NOM)$ is the nominal Zener voltage measured at the low test current used for voltage classification.

SOT-23 PACKAGE OUTLINE DIMENSIONS



Symbol	Dimensions In Millimeters		Dimensions In Inches	
	Min.	Max.	Min.	Max.
A	0.900	1.150	0.035	0.045
A1	0.000	0.100	0.000	0.004
A2	0.900	1.050	0.035	0.041
b	0.300	0.500	0.012	0.020
c	0.080	0.150	0.003	0.006
D	2.800	3.000	0.110	0.118
E	1.200	1.400	0.047	0.055
E1	2.250	2.550	0.089	0.100
e	0.950 TYP.		0.037 TYP.	
e1	1.800	2.000	0.071	0.079
L	0.550 REF.		0.022 REF.	
L1	0.300	0.500	0.012	0.020
θ	0°	8°	0°	8°